



WIZARD PLANTERS

VACUUM PRECISION PLANTERS

PRODUCT CATALOGUE



WIZARD let you seed:



and many others...

WIZARD PLANTERS

WIZARD srl company was born to implement our over 30 years background on agro-industrial area, mainly on vacuum precision planters.

We have designed a range of vacuum precision planters to give several solutions to all customers who needs to seed a wide range of crops.

WIZARD planters are suitable for planting all types of monogerm seeds, horticulture and more.



ACCURACY AND ADAPTABILITY

Our seeders, being equipped with a vacuum metering unit, stand out for their adaptability to different types of seeds.

The seeder can sow small seeds such as carrots, onions, salads and many more up to larger seeds such as corn, beans, soybeans and many others.

The change of the type of seed and the sowing distance on the row is made with simple and quick adjustments.

The seed metering unit is designed to work even at much higher speeds than the actual working speed, this guarantees high precision.

The adaptability of our vacuum metering unit is also given by the sowing systems R2 and R3.

These systems transform each single sowing unit with 1 line into 2 and 3 sowing lines in a very short time and without using tools.

They can be applied to all our models and have the advantage that the seeder can be transformed in a short time and therefore switch from sowing pumpkin, courgettes, corn etc. to the specific sowing of vegetables quickly.

Our planters are adaptable to a wide range of users as well as crops. They can be used in greenhouse and in open field, by seed producers or by those who have small plots of land to reduce costs.

MODULARITY AND MANAGEABILITY

The modularity of our seeders allows to satisfy the need, by adapting the same machine from sowing crops that need a large surface for the germination, such as pumpkin, corn, courgettes, melons etc. to crops that need less surface like most vegetables. The gearbox mounted on each sowing unit allows great modularity and customization of the seeders.

This modularity also gives the possibility of being able to ship partially disassembled, boxed and therefore considerably reduce the paking dimensions.

The reduced weight and size of our entire range allows easy handling, even inside greenhouses as well as in transportation.

All this while maintaining the sowing quality that distinguishes precision pneumatic sowing.

OUR RANGE

The **WZ-A series** are self-propelled models powered by a 4-stroke engine with a 4.5 HP. It has 1, 2 or 3 sowing units.

The **WZ-C series**, models that are applied to a two wheel tractor (BCS, Pasquali, Ferrari, Nibbi, Bertolini and Goldoni) and have 1, 2 or 3 sowing units.

The **WZ-D series**, seeders for medium-small tractors (about 50 HP, forward speed of about 3 km/h). The WZ-D series consists of 1 up to a maximum of 5 sowing units. Suitable for a wide range of crops.

The **WZ-E series**, an eco self-propelled, battery-powered seeder. The drive and the vacuum fan are electrically controlled and it is suitable for planting in greenhouses.

The **WZ-F series**, planters for small tractors, focused for horticulture farmers and raised bed seeding. Equipped with up to 8 sowing units.

The **WZ-G series** is equipped with a 12V vacuum fan and consequently the seeders of this series do not need any PTO to operate. They connect to the 3 linkage points and the 12V battery of the tractor.

The **WZ-G series** is equipped with a 12V vacuum fan and consequently the seeders of this series do not need any PTO to operate. They connect to the 3 linkage points and the 12V battery of the tractor.

The **WZ-GT** version is equipped with a double fan which, via a special manifold, is used as a single vacuum fan. This allows for greater suction power.

The **SWITCH** distance variable chassis can be applied to the models of the WZ-D and WZ-G/GT series which allows the movement of the sowing units and the consequent variation of the distance between the rows in a simple and rapid way.

The models with the SWITCH chassis are called **WZ-DS**, **WZ-GS** and **WZ-GTS**.

Furthermore, the WZ-C, WZ-D WZG models are **fully customizable** according to customer needs.

This customization increase possibilities of finding the solution for farmer requires.

· CROPS ·

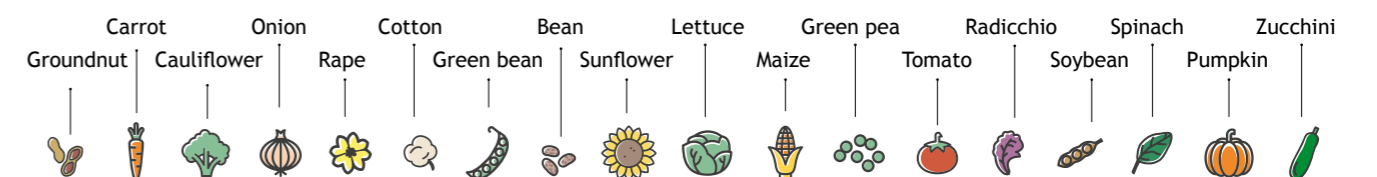

and many others...

W5 VACUUM METERING UNIT

The W5 vacuum metering unit has been developed with flexibility as a fundamental principle and perfectly matches the philosophy of the WIZARD range of seed drills.

Designed to satisfy the use of a wide range of seeds with the quality that distinguishes the pneumatic sowing technology.



A SEED DISCS

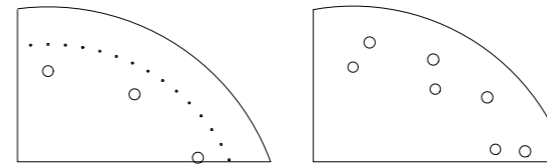

The stainless steel discs, thanks to their reduced thickness, remain in constant adherence to minimizing the waste of air and ensuring a constant load of the seed. The dimensions of the holes in which the air passes have various dimensions based on the size, shape and weight of the seed. The number of holes on the disc is chosen according to the user's needs and with the many possibilities it covers from the shortest distances, for the sowing of vegetables, up to long distances for the sowing of which requires a lot of surface.

B SEED SINGULATOR

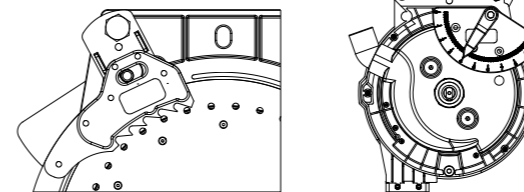

The seed singulator allows you to improve sowing as it eliminates double seeds and reduces to one seed per hole. Often using irregularly shaped seeds, the correct use of the singulator is as important as its adjustment. The seed singulator is constantly in contact with the sowing disc during the working phase and thanks to its adjustable toothed shape it avoids the passage of more than one seed per hole without damaging them, promoting germination.

C EJECTORS/SEED GUIDES

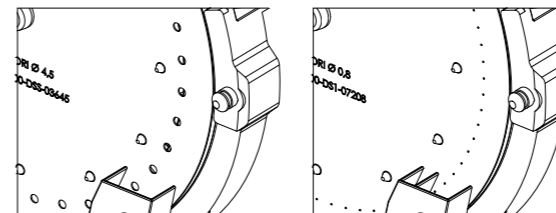

The ejectors, in contact with the sowing disc, ensure the expulsion of the seed continuously and constantly. They also act as a guide to the seeds until they reach the seed tube. The ejectors are 2 models, for small seeds and for larger seeds. In cases of large seeds and low feed speeds, the ejector can also be removed and the metering unit used without it.

D GASKET

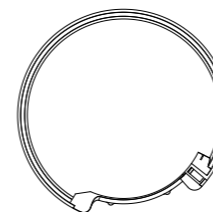

The rigid plastic gasket allows the opening and closing of the depression exactly where it is needed. The gasket allows the loading of the seeds near the dispenser loading chamber while the vacuum cut-off where the seed detachment takes place, thus obtaining high sowing precision. The seal and its position are designed to work optimally both with single sowing line and also with 2 and 3 sowing lines.

E EASE-OF-USE

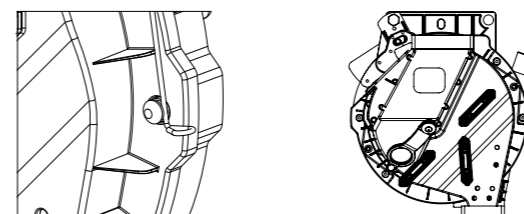

The use and set up of our sowing metering unit are simple and quick, starting from the opening of the cover which does not require any tools. The vacuum metering unit is designed to be easily adjustable even during use in the field.

R2-R3 MULTILINE SOLUTIONS

Our R2 and R3 multiline solutions are designed to be perfectly adaptable to the metering unit and to the seeders in our range.

Multiline solutions R2 and R3 are designed to optimize the sowing of vegetable seeds and allow to sow 2 and 3 sowing lines respectively 9 and 4.5 cm apart for each unit.

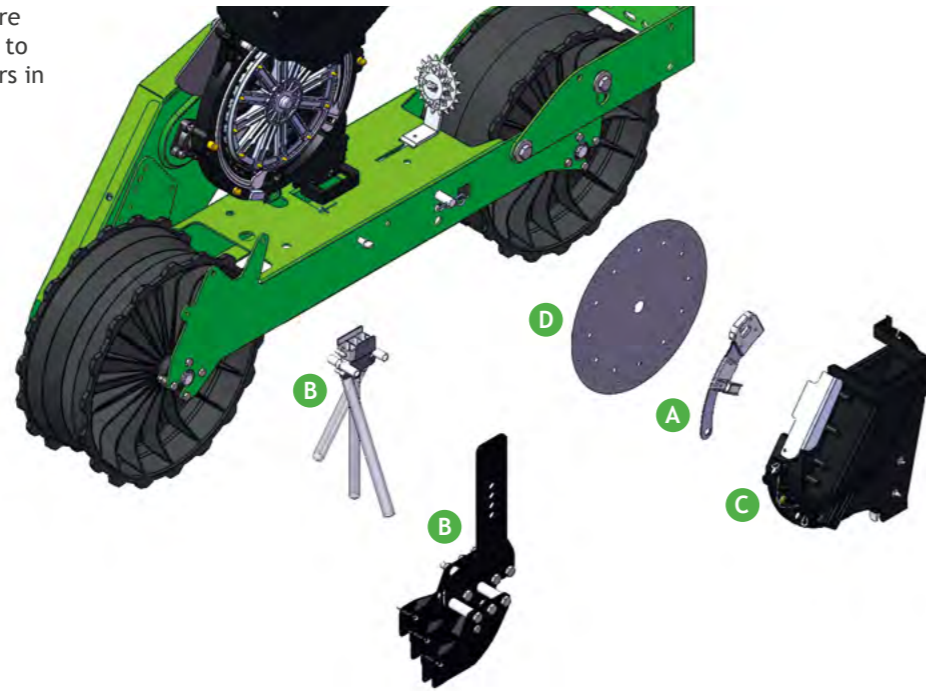

The R2 and R3 solutions are also easily interchangeable with the standard single row seeding system.

The user, therefore, has the possibility of having 2 seeders in 1 for all purposes.

This is possible by transforming, in a simple and quick way without the use of tools, its single-line seeder into a double or triple-line seeder.

This feature allows you to sow a wide variety of crops with a single WIZARD seeder, without compromise, quickly switching from sowing crops such as corn, sunflower, beans etc. single line for sowing carrots, onions and all vegetables that require a double or triple line.



2 IN 1

A SEED SINGULATOR



A single selector for the solution R2 with 2 sowing lines and another one for the solution R3 with 3 sowing lines. Simple to apply both without tools. This singulators replaces the single row seed selector. They adhere perfectly to the disc and avoids the passage of more than one seed per hole without damaging them. Both singulators have toothed sectors which, with their parallel position, work uniformly on the respective rows of seeds.

B SHOE OPENERS AND SEED TUBES

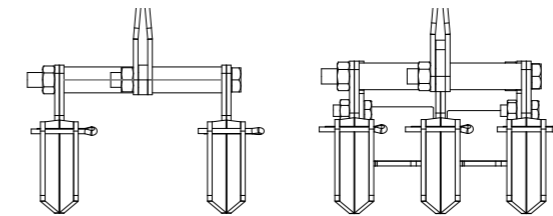

The R2 shoe opener allows the sowing of 2 lines at a distance of 9 cm while the R3 shoe opener is used to sow 3 lines at 4.5 cm. The R3 shoe opener is also equipped with an anti-clogging limiter between the jaws due to the reduced unloading space between the jaws. Specific seeding tubes for minute seeds are inserted in both the R2 and R3 shoe opener.

C METERING UNIT COVER

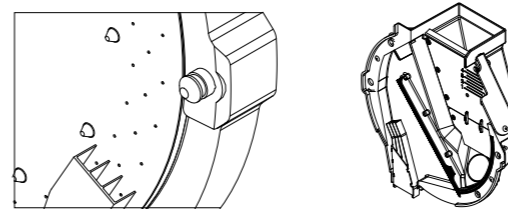

The multiline cover is a essential part for multiline sowing. It is equipped with an ejector which is divided into 3 sections which guarantee the fall of the minute seeds and guide them up to the sections of the seed tube. In addition to this, 2 opening windows allow you to check the seeds along the entire path inside the distributor and a brush to keep the sowing disc constantly clean. The gaskets present in the cover of the multiline distributor have a position that allows the complete passage of the 3 sowing lines.

D SEED DISCS

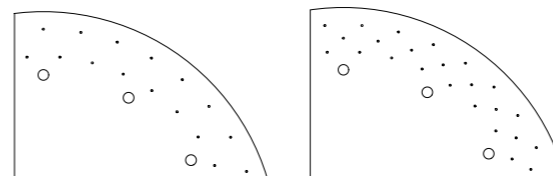

They are equipped with 2 and 3 sowing lines respectively, and both type are compatible with the metering unit cover and the multi-line seed singulator. They have holes in size and shape suitable for small seeds and their transport. Even in multi-row discs, the number of holes determines the seeding distance on the line and thanks to the wide choice we are able to satisfy most of the user's needs.

CROPS layout

STANDARD

1 sowing line
each unit

WZ-D30 STD =
3 sowing lines

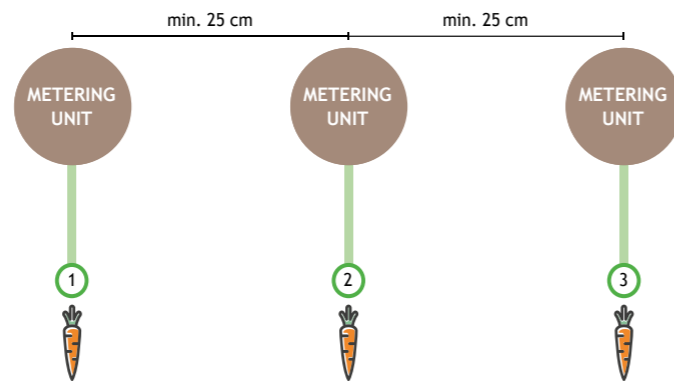

STANDARD DS1

- RAPE CORIANDER SPINACH BROCCOLI
 - CABBAGE TOMATO BORAGE CARROT
 - ONION PARSLEY POPPY RADICCHIO
 - RADISH LETTUCE CUCUMBER LAMB'S LETTUCE
- and many others...

DSS

- CHICKPEA BEAN
 - WATERMELON GREEN BEAN SUNFLOWER
 - GROUNDNUT MAIZE GREEN PEA
 - SUGAR BEET SORGHUM SOYBEAN
 - EGGPLANT PUMPKIN COTTON
- and many others...



R2

2 sowing lines
each unit

WZ-D30 + R2 =
6 sowing lines

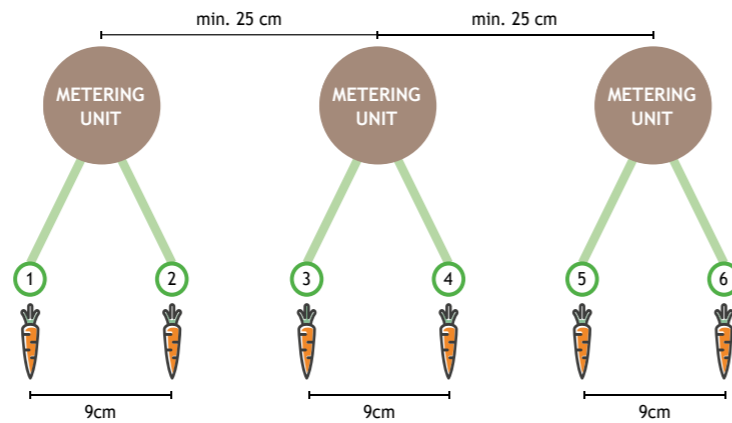

R2 DS2

- ONION PEPPER MUSTARD
- PARSLEY TURNIP SPINACH
- TOMATO LETTUCE CARROT
- LEEK RADICCHIO



R3

3 sowing lines
each unit

WZ-D30 + R3 =
9 sowing lines

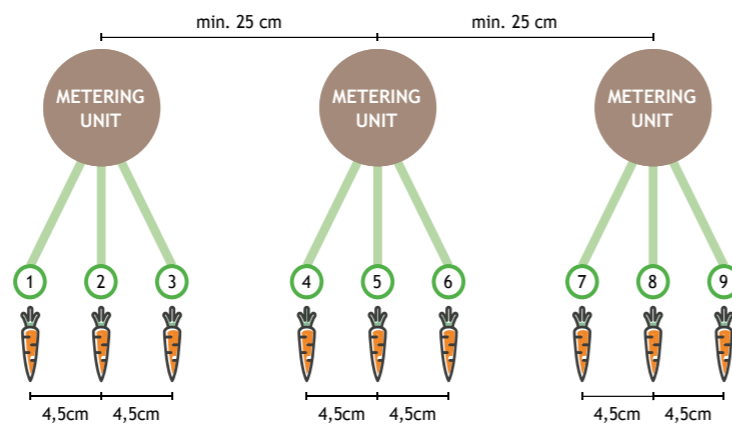

R3 DS3

- SALVIA
- CORIANDER
- RADISH
- SPINACH
- TURNIP
- CARROT
- PARSLEY

SEED DISCS FOR R2 AND R3 SOLUTIONS

Shoe opener	Seeds	Small seeds
STANDARD	DSS	DS1
R2	/	DS2
R3	/	DS1 - DS2 - DS3

- DSS Standard
- DS1 1 line small seeds
- DS2 2 lines small seeds
- DS3 3 lines small seeds

Richiedi le tabelle per conoscere le colture specifiche per ogni tipo di disco di semina.

Imballaggio WIZARD

Our range of vacuum precision planters has been designed not only to have an excellent reliability, but also to be easily disassembled, packed, and shipped.

Once at destination they can be quickly and easily assembled and ready for working.

This way packaging volume and high costs of transportation will be reducing and having an significant impact on the final cost of planter.

COMPACT



ex. 1 x WZ-A10



MEDIUM



ex. 1 x WZ-D30

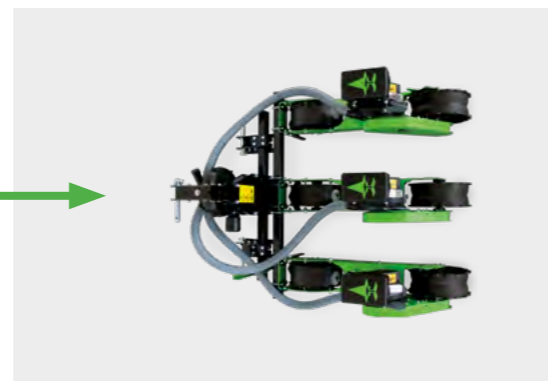

COMBINATION



ex. 9 x WZ-A10

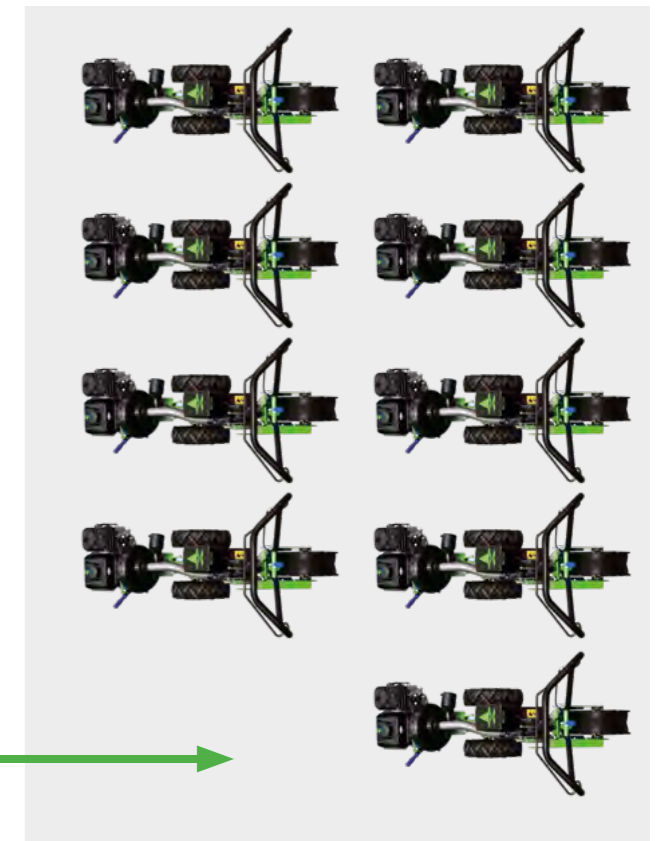

ex. 5 x WZ-D20



ex. 3 x WZ-D40

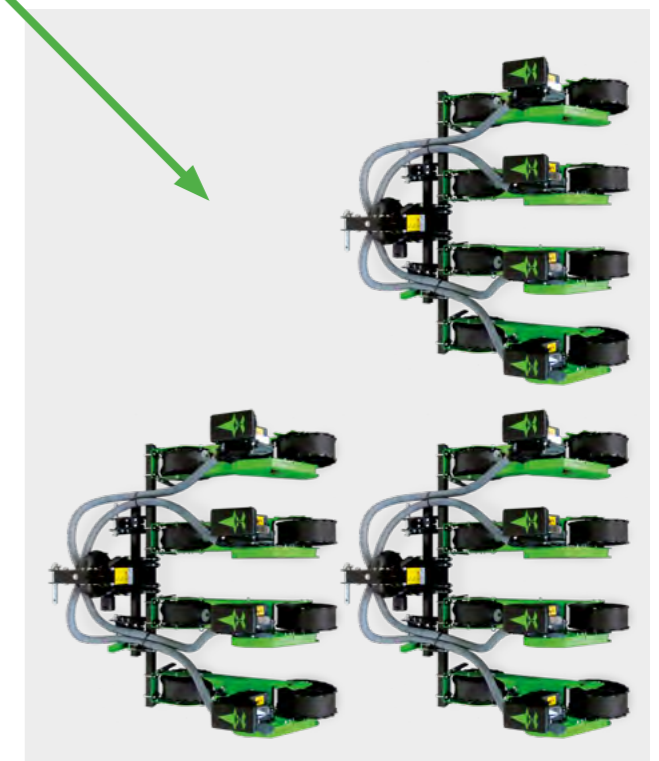



SELF-PROPELLED

- WZ-A SERIES
- WZ-E SERIES

WZ-A Series

The WZ-A Series includes 3 self-propelled models powered by a 4.5hp 4-stroke engine. It consists of 1, 2 or 3 sowing units which can be mounted at a minimum distance of 25 cm.



- 1 4 stroke engine - 4,5 hp
- 2 Vacuum fan
- 3 Drive wheels
- 4 Soil leveler
- 5 Sowing vacuum metering unit
- 6 3 liters seed hopper
- 7 Shoe opener and seed tube
- 8 Sowing depth adjustment
- 9 Gearbox for seeding distance adjustment
- 10 Closing wheel and metering unit traction
- 11 Safety advancement lever



A Closing wheel and metering unit traction

B Vacuum precision sowing unit

DATA CHART

	N° row	Row distance [cm]	Chassis [cm]	Width [cm]	Length [cm]	Height [cm]	Weight [kg]
WZ-A10	1	-	-	53	170	95	64
WZ-A20	2	45	70	70	180	105	105
WZ-A21	2	75	100	100	180	105	105
WZ-A30	3	45	120	120	180	105	126

ACCESSORIES



R2 and R3 SOLUTIONS
page details 6-7

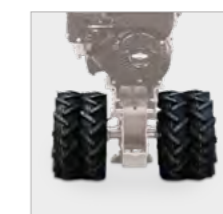

Double wheel traction



Raised bed sowing
WZ-A10 only



Rear pivot wheel
WZ-A20 and WZ-A30 only

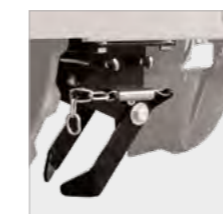

Seed coverer

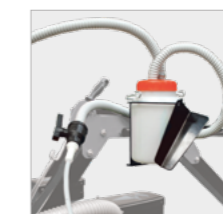

Seed clean out



Flat closing wheel



Seed discs

ACCESSORIES details on page 46-47

WZ-E Series

The WZ-E series, an eco self-propelled, battery-powered seeder. The drive and the vacuum fan are electrically controlled. It is suitable for planting in greenhouses, where farmers may have problems with emissions.



- 1 VRLA battery 12V
- 2 Electric vacuum fan
- 3 Electric drive wheels
- 4 Sowing vacuum metering unit
- 5 3 liters seed hopper

- 6 Shoe opener and seed tube
- 7 Sowing depth adjustment
- 8 Gearbox for seeding distance adjustment
- 9 Closing wheel and metering unit traction
- 10 Safety advancement lever

FULL ELECTRIC DRIVE

- Switch on/switch off
- Fan adjustment
- Speed adjustment
- Battery check



ECO-ADVANTAGES

- Zero-emissions
- Rechargeable Battery
- Electric advancement
- Electric fan
- Easy speed-vacuum adjustment
- Safety relase

ECO-USERS

- Greenhouses
- Laboratory test
- Seed producer
- Small seeding plots
- Developing countries
- Hobby or semi-professional
- Farmers km 0
- Horticulture with small plots and many others

	N° row	Row distance [cm]	Chassis [cm]	Width [cm]	Lenght [cm]	Height [cm]	Weight [kg]
WZ-E10	1	-	-	50	150	95	61





TWO-WHEEL TRACTOR USERS

- WZ-C SERIES
- WZ-C COMPACT SERIES
- WZ-C/C COMPACT CUSTOMIZED

WZ-C Series

The WZ-C Series, models that are applied to a two wheel tractor (BCS, Pasquali, Ferrari, Nibbi, Bertolini and Goldoni) and have 1, 2 or 3 sowing units. The WZ-C series with reduced size has been named COMPACT.

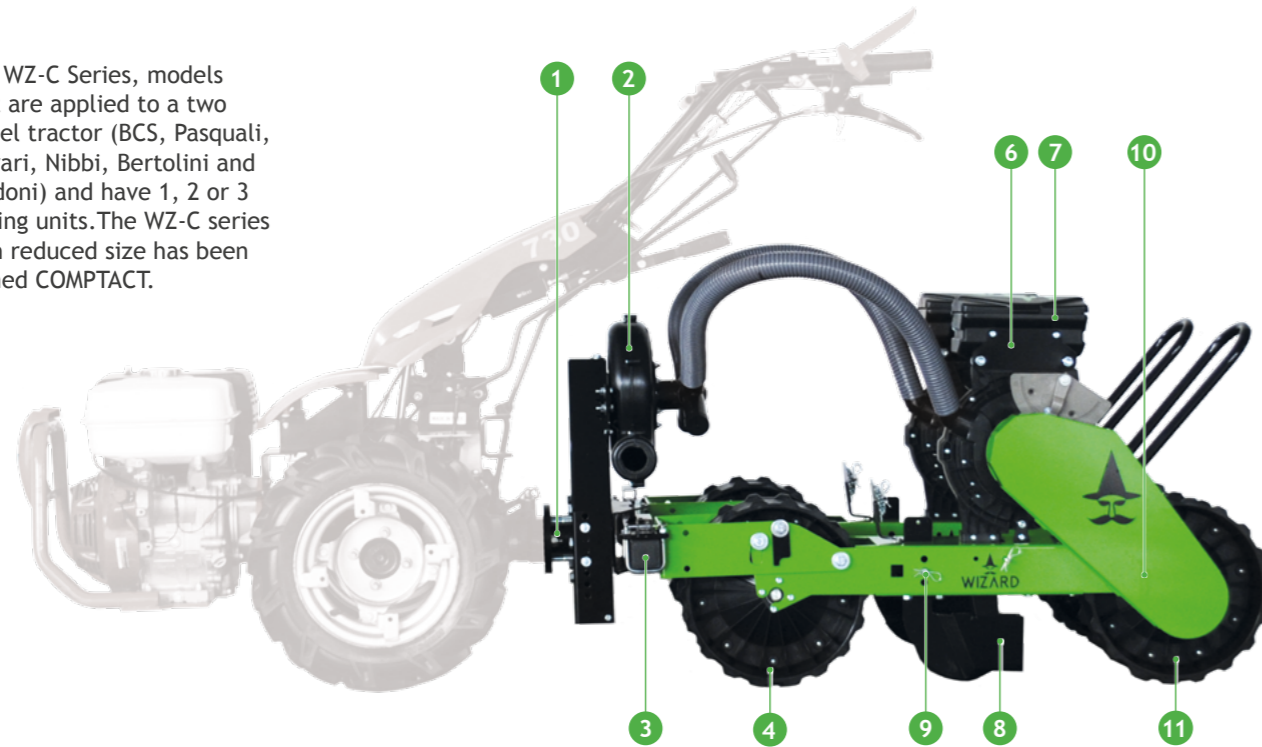

- 1 PTO connection
- 2 Vacuum fan
- 3 Chassis
- 4 Soil leveler wheel
- 5 Clod remover leveler (WZ-C COMPACT)
- 6 Sowing vacuum metering unit
- 7 3 liters seed hopper
- 8 Shoe opener and seed tube
- 9 Sowing depth adjustment
- 10 Gearbox for seeding distance adjustment
- 11 Closing wheel and metering unit traction

	N° row	Row distance [cm]	Chassis [cm]	Width [cm]	Lenght [cm]	Height [cm]	Weight [kg]	PTO connection
WZ-C10	1	-	30	30	125	80	36	BCS PASQUALI FERRARI NIBBI BERTOLINI FORT GOLDONI
WZ-C20	2	45	70	70	125	80	58	
WZ-C21	2	75	100	100	125	80	58	
WZ-C30	3	45	120	120	125	80	80	

WZ-C COMPACT

It's the lighter and shorter version of WZ-C, easy to handle in working and in transport thankful to his reduced dimensions and keeping same sowing quality.

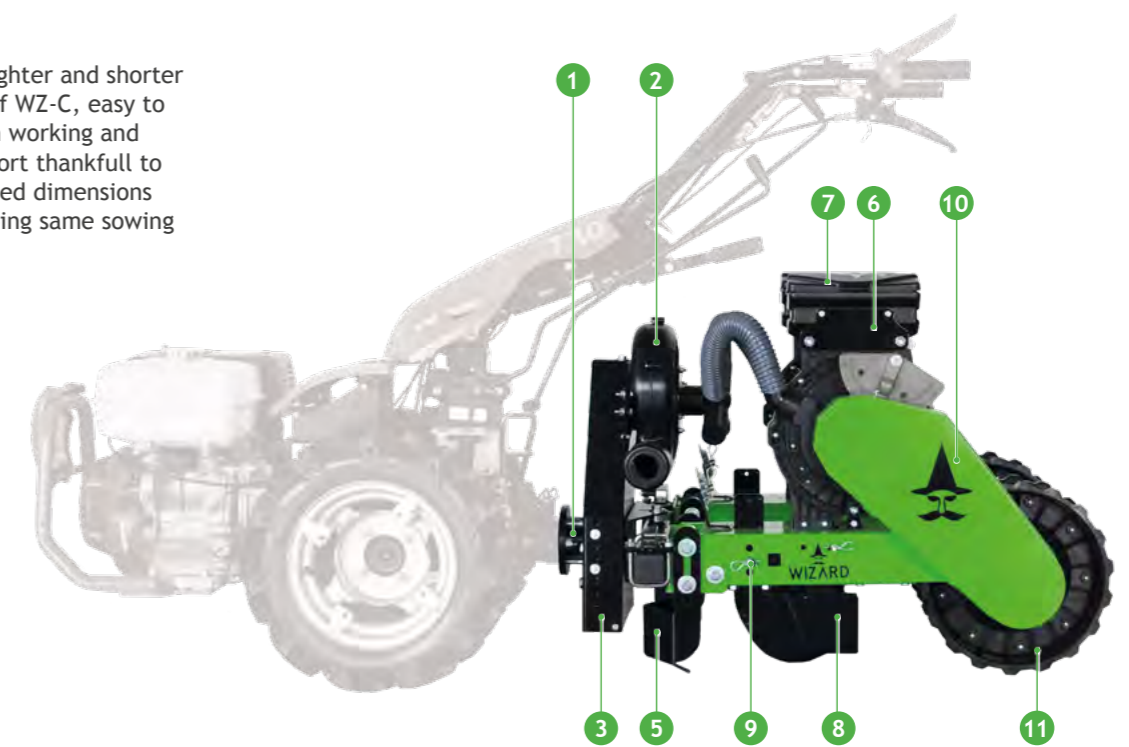

	N° row	Row distance [cm]	Chassis [cm]	Width [cm]	Lenght [cm]	Height [cm]	Weight [kg]	PTO connection
WZ-C10	1	-	30	30	95	80	33	BCS PASQUALI FERRARI NIBBI BERTOLINI FORT GOLDONI
WZ-C20	2	45	70	70	95	80	52	
WZ-C21	2	75	100	100	95	80	52	
WZ-C30	3	45	120	120	95	80	71	

WZ-C10

WZ-C20

WZ-C30

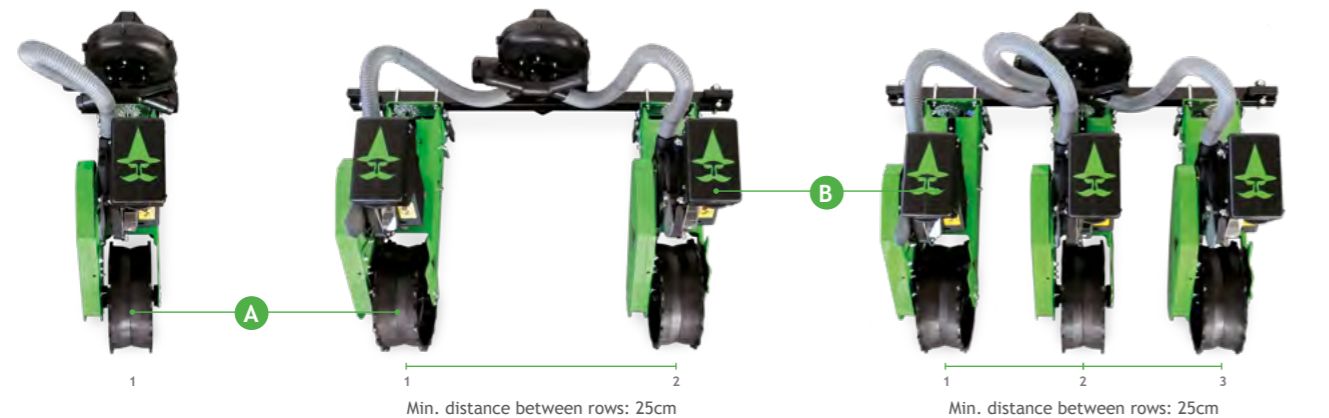

A Closing wheel and metering unit traction

B Vacuum precision sowing unit

WZ-C AND WZ-C COMPACT ACCESSORIES

ACCESSORIES details on page 46-47



R2 and R3 SOLUTIONS
page details 6-7

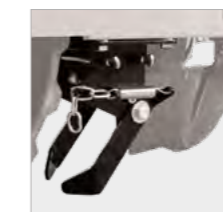

Seed coverer



Clod-remover
WZ-C only

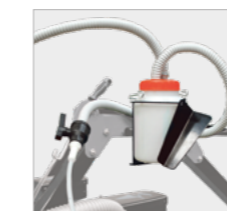

Seed clean out



Flat closing wheel



Seed discs

WZ-C Series CUSTOMIZED

Build your own WZ-C planter choosing from various shown components according to your needs.



TWO-WHEEL TRACTOR CONNECTION *

PTO connection fully mounted with vacuum fan and row marker



* Specify for which model among: BCS, Pasquali, Ferrari, Nibbi, Bertolini, Fort and Goldoni

SOWING UNIT Kit 1050 WZ-C

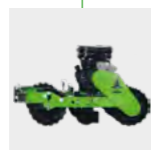

SOWING UNIT Kit 1050 COMPACT

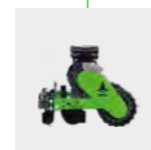

CHASSIS

4 different width chassis available

STANDARD
30, 70,
100, 120 cm



VACUUM PIPE

ANTI-UV Spiral tube

Ø40 Anti-UV



ACCESSORIES on page 46-47





TRACTOR USERS

- WZ-D SERIES
- WZ-D SERIES CUSTOMIZED
- WZ-DS SWITCH SERIES
- WZ-DS SWITCH SERIES CUSTOMIZED
- WZ-F SERIES
- WZ-F SERIES MULTILINE
- WZ-G SERIES
- WZ-GT SERIES
- WZ-G/GT SERIES CUSTOMIZED
- WZ-GS SERIES
- WZ-GTS SERIES
- WZ-GS/GTS SERIES CUSTOMIZED

WZ-D Series

The WZ-D Series, seeders for medium-small tractors (about 50 HP). The WZ-D series consists of 1 up to a maximum of 5 sowing units and the distance between them goes from 25 cm up. Suitable either for sowing on open field and on raised bed.

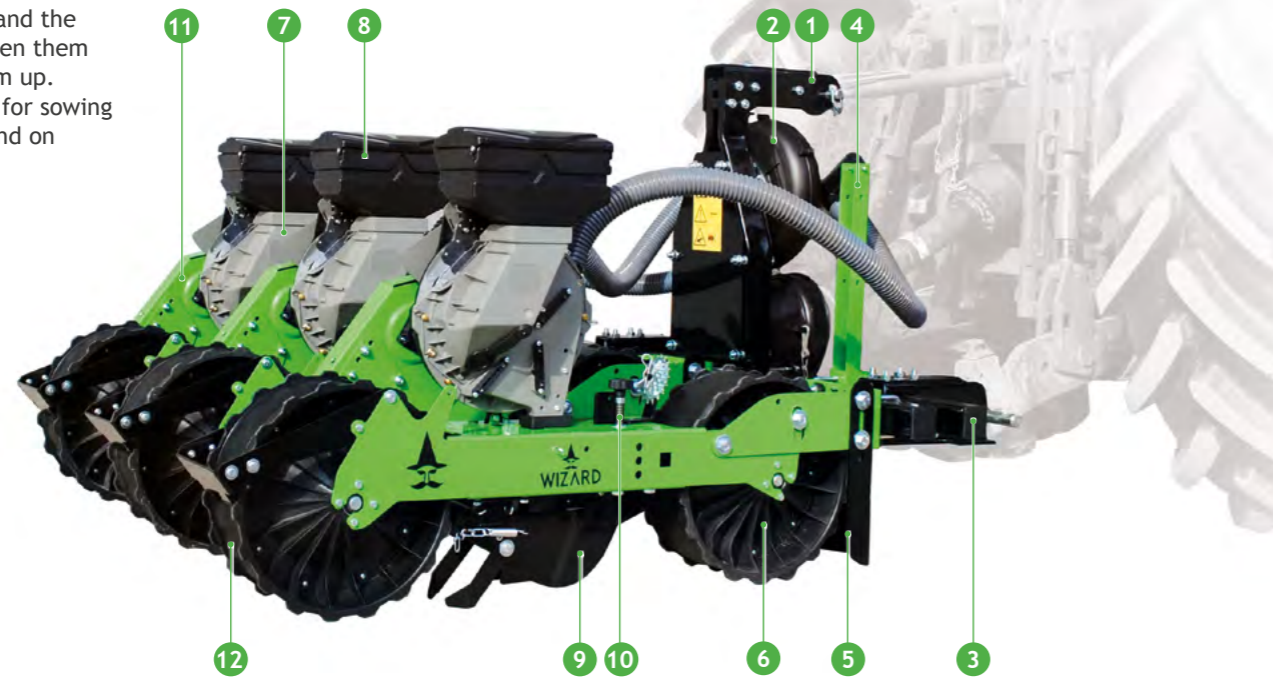

- 1 Three point linkage - CAT.1 and CAT.2
- 2 Vacuum fan
- 3 Chassis
- 4 Parking stand
- 5 Clod remover
- 6 Soil leveler wheel
- 7 Sowing vacuum metering unit
- 8 3 liters seed hopper
- 9 Shoe opener and seed tube
- 10 Screw sowing depth adjustment
- 11 Gearbox for seeding distance adjustment
- 12 Heavy closing wheel and metering unit traction

DATA CHART

	N° row	Row distance [cm]	Chassis [cm]	Width [cm]	Lenght [cm]	Height [cm]	Weight [kg]	Power [hp]
WZ-D10	1	-	120	120	140	80	79	15
WZ-D20	2	45/75/90	120	120	140	80	100	15
WZ-D30	3	45	120	120	140	80	127	25
WZ-D31	3	75	175	175	140	80	129	25
WZ-D40	4	45	160	160	140	80	162	25
WZ-D41	4	75	250	250	140	80	169	30
WZ-D50	5	30	160	160	140	80	191	30
WZ-D51	5	50	250	250	140	80	198	30

ACCESSORIES



R2 and R3 SOLUTIONS
page details 6-7



Double disc opener



Seed coverer



Scraper



Vacuum gauge



Seed clean out



15 L seed hopper



Row marker



Flat closing wheel



Seed discs

ACCESSORIES details on page 46-47

WZ-D Series CUSTOMIZED

Build your own WZ-D planter choosing from various shown components, according to your needs.



TWO-WHEEL TRACTOR CONNECTION

3 point linkage fully mounted with PTO connection and vacuum fan

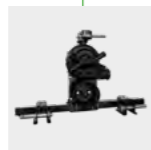

SOWING UNIT

Kit 1050 WZ-D

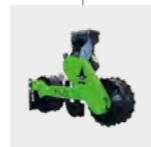

CHASSIS

different width chassis available

STANDARD
120, 160,
175, 250 cm



VACUUM PIPE

ANTI-UV Spiral tube



ACCESSORIES page 46-47



WZ-DS SWITCH

The WZ-DS series is a vacuum precision planter consisting of 2 or more sowing units with variable sowing distance. The SWITCH frame allows you to adjust the distance between the rows quickly and easily.



- 1 Three point link - CAT.1 / CAT.2
- 2 Vacuum fan
- 3 SWITCH chassis with variable row distance
- 4 Seeding unit shift lever
- 5 Parking stand
- 6 SWITCH clamp of sowing unit
- 7 Clod remover
- 8 Soil leveler wheel
- 9 Sowing vacuum metering unit
- 10 3 liter seed hooper
- 11 Shoe opener and seed tube
- 12 Screw Sowing depth adjustment
- 13 Gearbox for seeding distance adjustment
- 14 Heavy closing wheel and metering unit traction

4 SWITCH CHASSIS



The SWITCH chassis allows the movement of the sowing units quickly and easily thanks to the movement lever that is supplied. This system allows you to switch from one crop to another with different needs even more quickly. Developed for those who often change crops with very different space requirements. The distance between the sowing units has a pitch of 1.25 cm in machines with an odd number of rows and 2.5 cm in machines with an even number of rows. The distance goes from a minimum of 25 cm adjustable up to a maximum which depends on the size of the frame and the quantity of sowing units.

DATA CHART

	N° row	Row distance [cm]		Chassis [cm]	Width [cm]	Lenght [cm]	Height [cm]	Weight [kg]	Power [hp]
		min	max						
WZ-DS20	2	25	90	120	120	146	80	110	15
WZ-DS30	3	25	45	120	120	146	80	141	25
WZ-DS31	3	25	75	180	180	146	80	147	25
WZ-DS40	4	25	45	160	160	146	80	183	25
WZ-DS41	4	25	75	250	250	146	80	202	30
WZ-DS50	5	25	30	160	160	140	80	215	30
WZ-DS51	5	25	50	250	250	146	80	233	30

ACCESSORIES



R2 and R3 SOLUTIONS
page details 6-7



Double disc opener



Seed coverer



Scraper



Vacuum gauge



Seed clean out



15 L seed hopper



Row marker



Flat closing wheel



Seed discs

ACCESSORIES details on page 46-47

WZ-DS Series CUSTOMIZED

Build your own WZ-D planter choosing from various shown components, according to your needs.



TWO-WHEEL TRACTOR CONNECTION

3 point linkage fully mounted with PTO connection and vacuum fan

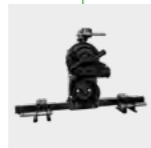

SOWING UNIT

Kit 1050 WZ-DS

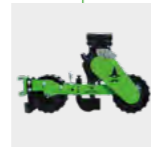

CHASSIS

different width chassis available

SWITCH
120, 160, 180,
250 cm



VACUUM PIPE

ANTI-UV Spiral tube



ACCESSORIES page 46-47

WZ-D/DS sowing layouts

The WZ-D and WZ-DS series have skills that make them very flexible:

- Reduced weight
- Single transmission on each sowing unit
- Distance between rows easy to change
- Easy to change crops

The versatility of this planter is represented in some layouts illustrated below:

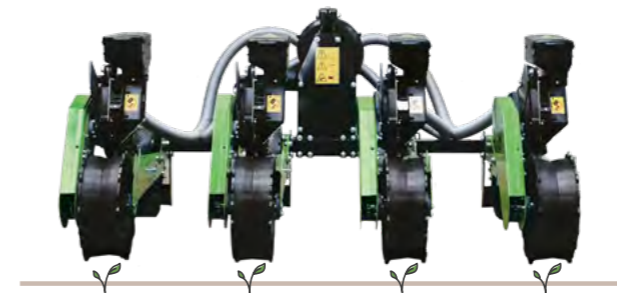

Traditional field

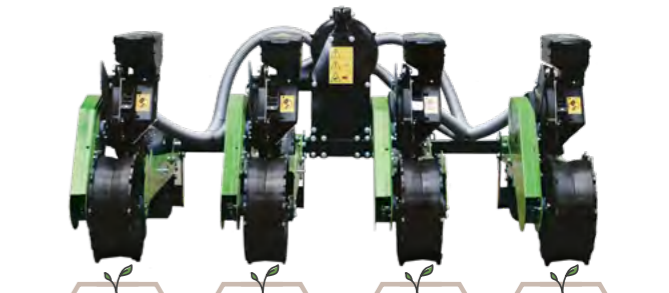

1 sowing unit each raised bed

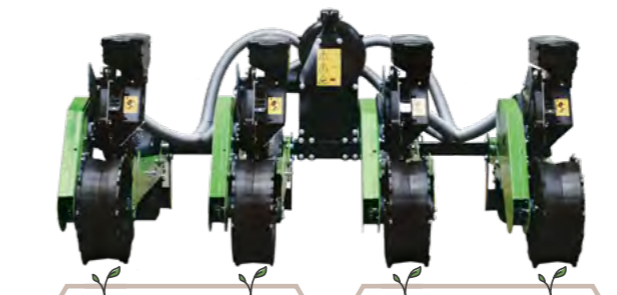

Mores sowing unit each bed

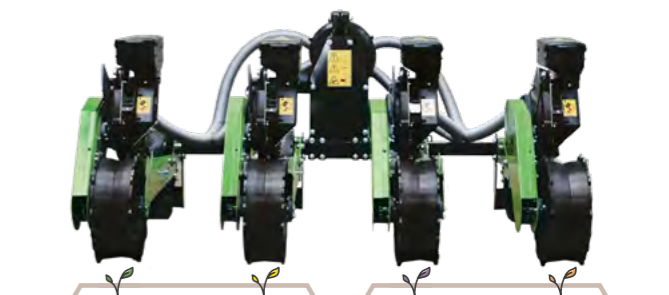

More sowing units each bed and different crops



WZ-F Series

The WZ-F series, planters for small tractors (approx. 50 HP). Suitable for horticulture and vegetable farmers. Specific for sowing on raised bed given by the height-adjustable wheels.



- 1 Three point linkage - CAT.1 and CAT.2
- 2 Vacuum fan
- 3 Vacuum gauge
- 4 Adjustable height wheel max. 20 cm
- 5 Chassis
- 6 Clod remover leveler
- 7 Sowing vacuum metering unit
- 8 3 liters seed hopper
- 9 Shoe opener and seed tube
- 10 Screw sowing depth adjustment
- 11 Gearbox for seeding distance adjustment
- 12 Closing wheel and metering unit traction

ACCESSORIES



R2 and R3 SOLUTIONS
page details 6-7



Seed coverer



Scraper



Seed clean out



15 L seed hopper



Flat closing wheel



Seed discs

ACCESSORIES details on page 46-47

DATA CHART

	N° row	Row distance [cm]	Chassis [cm]	Width [cm]	Length [cm]	Height [cm]	Weight [kg]	Power [hp]
WZ-F40	4	22,5	120	155	190	80	180	40
WZ-F50	5	22,5	160	195	190	80	210	40
WZ-F70	7	22,5	200	235	190	80	255	50
WZ-F80	8	22,5	225	260	190	80	280	50



WZ-F sowing layouts

The WZ-F series has characteristics that make it suitable for sowing vegetables on raised bed, even in small greenhouses:

- Reduced and homogeneous distance between the sowing units
- Height adjustable side wheels
- Low weight
- Easy crop change

The ductility of this seeder is represented in some configurations illustrated below.

WZ-F50 and WZ-F70



Traditional field



On raised bed

WZ-F40 and WZ-F80



Traditional field



On raised bed



On 2 raised bed

WZ-F R2-R3 MULTILINE

In the WZ-F series, the R2-R3 solutions are enhanced by the homogeneity of the distance between the sowing lines, bringing the distance to 9 cm and 4.5 cm from the first to the last line without any detachment between the sowing units.

STANDARD

5 sowing line each unit x 12,5 cm

Sowing line distance: 12,5 cm

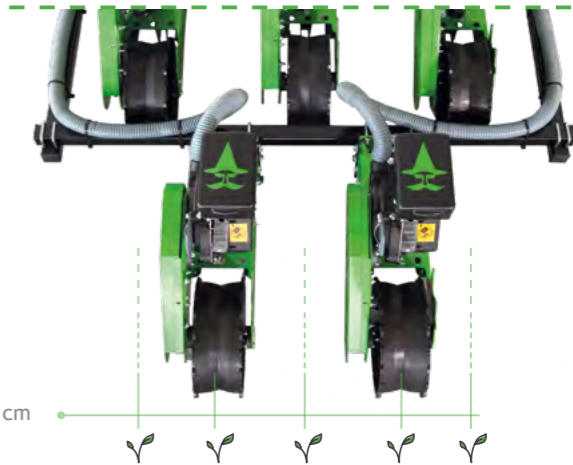

R2

10 sowing line each unit x 9 cm

Sowing line distance: 9 cm



R3

15 sowing line each unit x 4,5 cm

Sowing line distance: 4,5 cm



WZ-G Series

The WZ-G Series includes seed drills for small to medium sized tractors (about 50 hp). This series of seeders is equipped with a 12V powered vacuum fan and therefore does not require any PTO for use. Suitable for all those tractors or tool carriers that are without PTO. In addition, the vacuum fan control system can also be mounted on any additional type of frame and create the pneumatic precision seeder suitable for various types of tool-carrier tractors.



- 1 Three point linkage - CAT.1/ CAT. 2
- 2 Vacuum fan 12V
- 3 Control box
- 4 Power box
- 5 Power cable 500 cm
- 6 Vacuum gauge
- 7 Chassis
- 8 Parking stand
- 9 Clod remover
- 10 Soil wheel leveler
- 11 Sowing vacuum metering unit
- 12 3 liter seed tank
- 13 Shoe opener and seed tube
- 14 Screw sowing depth adjustment
- 15 Change for seeding distance adjustment
- 16 Heavy closing wheel and metering unit traction

	N° row	Row distance [cm]	Chassis [cm]	Width [cm]	Lenght [cm]	Height [cm]	Weight [kg]	Power [cv]
WZ-G10	1	-	120	120	140	80	74	15
WZ-G20	2	45/75/90	120	120	140	80	95	15

VACUUM FAN 12V



The 12V vacuum fan allows you to apply this series of seeders to any type of tractor or tool-carrier without the need for a cardan connection or an applied hydraulic motor. In addition to the 3 point linkage, it only needs to be connected to the 12V battery of the tractor on which it is applied. The planter absorbs a reduced amount of amps in work, maximum 35A. The vacuum fan is managed by a power box with on/off on the machine and the power regulated by a control box on the tractor.

WZ-GT Series

The WZ-GT series is the double depressor version of the WZ-G series. Therefore we would have greater power which allows us to use up to 2 seeding units without any limits and up to 4 with limits on the size and quantity of holes.



DATA CHART

	N° row	Row distance [cm]	Chassis [cm]	Width [cm]	Lenght [cm]	Height [cm]	Weight [kg]	Power [cv]
WZ-GT10	1	-	120	120	140	80	85	15
WZ-GT20	2	45/75/90	120	120	140	80	105	15
WZ-GT30	3	45	120	120	140	80	127	25
WZ-GT40	4	45	160	160	140	80	162	25

DOUBLE VACUUM FAN 12V



The 12V double vacuum fan is regulated by a single controller and both vacuum fan are connected to a manifold which unifies the vacuum. The advantage is that both from the point of view of the management of the vacuum fans and from the point of view of the vacuum control it is all unified through a single controller and a single vacuum gauge, like the WZ-G series.

ACCESSORIES



R2 and R3 SOLUTIONS
page details 6-7



Double disc
opener

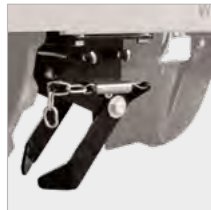

Seed coverer

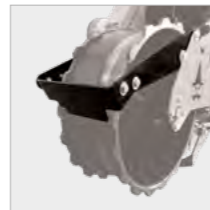

Scraper



15 L seed hopper

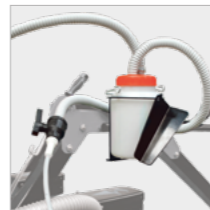

Seed clean out



Flat closing
wheel



Seed discs

ACCESSORIES DETAILS on page 46-47

WZ-G/GT Series CUSTOMIZED

Build your own WZ-G/GT planter choosing from various shown components, according to your needs.

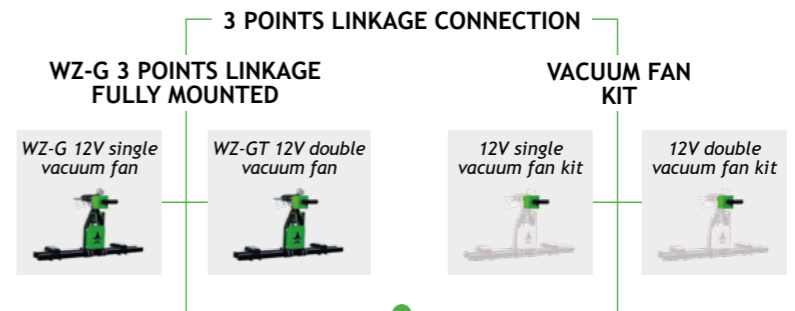

SOWING UNIT
Kit 1050 WZ-G



CHASSIS
different width chassis available

STANDARD
120, 160 cm



VACUUM PIPE
ANTI-UV Spiral tube

Ø40 Anti-UV



ACCESSORIES on page 46-47



Serie WZ-GS

The WZ-GS series is a small precision pneumatic planter consisting of 1 or 2 sowing units with variable sowing distance. The main features of this series are the 12V fan which does not require any cardan shaft for operation and the SWITCH chassis allows to adjust the distance between rows to be adjusted quickly and easily.



- 1 Three point linkage - CAT.1/ CAT. 2
- 2 Vacuum fan 12V
- 3 Control box
- 4 Power box
- 5 Power cable 500 cm
- 6 Vacuum gauge
- 7 SWITCH chassis with variable row distance
- 8 Parking stand
- 9 Clod remover
- 10 SWITCH clamp of sowing unit
- 11 Soil wheel leveler
- 12 Sowing vacuum metering unit
- 13 3 liter seed tank
- 14 Shoe opener and seed tube
- 15 Screw sowing depth adjustment
- 16 Change for seeding distance adjustment
- 17 Heavy closing wheel and metering unit traction

	N° row	Row distance [cm]	Chassis [cm]	Width [cm]	Lenght [cm]	Height [cm]	Weight [kg]	Power [cv]
WZ-GS10	1	-	120	120	146	80	84	15
WZ-GS20	2	45/75/90	120	120	146	80	105	15

VACUUM FAN 12V

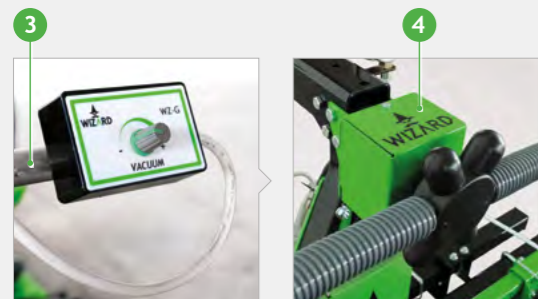

The 12V vacuum fan allows you to apply this series of seeders to any type of tractor or tool-carrier without the need for a cardan connection or an applied hydraulic motor. In addition to the 3 point linkage, it only needs to be connected to the 12V battery of the tractor on which it is applied. The planter absorbs a reduced amount of amps in work, maximum 30A. The vacuum fan is managed by a power box with on/off on the machine and the power regulated by a control box on the tractor.

Serie WZ-GTS

The WZ-GTS series is the double depressor version of the WZ-GS series. Therefore we would have greater power which allows us to use up to 2 seeding units without any limits and up to 4 with limits on the size and quantity of holes. The WZ-GTS series is also equipped with a SWITCH chassis which allows a quick change of distance between the sowing units.



DATA CHART

	N° row	Row distance [cm]		Chassis [cm]	Width [cm]	Lenght [cm]	Height [cm]	Weight [kg]	Power [hp]
		min	max						
WZ-GTS20	2	25	90	120	120	146	80	115	15
WZ-GTS30	3	25	45	120	120	146	80	131	25
WZ-GTS40	4	25	45	160	160	146	80	183	25

DOUBLE VACUUM FAN 12V



The 12V double vacuum fan is regulated by a single controller and both vacuum fan are connected to a manifold which unifies the vacuum. The advantage is that both from the point of view of the management of the vacuum fans and from the point of view of the vacuum control it is all unified through a single controller and a single vacuum gauge, like the WZ-G series.

4 SWITCH CHASSIS



The SWITCH chassis allows the movement of the sowing units quickly and easily thanks to the movement lever that is supplied. This system allows you to switch from one crop to another with different needs even more quickly. Developed for those who often change crops with very different space requirements. The distance between the sowing units has a pitch of 1.25 cm in machines with an odd number of rows and 2.5 cm in machines with an even number of rows. The distance goes from a minimum of 25 cm adjustable up to a maximum which depends on the size of the frame and the quantity of sowing units.

ACCESSORIES



R2 and R3 SOLUTIONS
page details 6-7

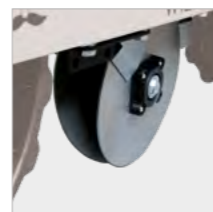

Double disc opener

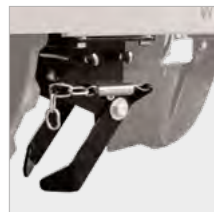

Seed coverer



Scraper



15 L seed hopper



Seed clean out



Flat closing wheel



Seed discs

ACCESSORIES DETAILS on page 46-47

WZ-GS/GTS Series CUSTOMIZED

Build your own WZ-GS/GTS planter choosing from various shown components, according to your needs.

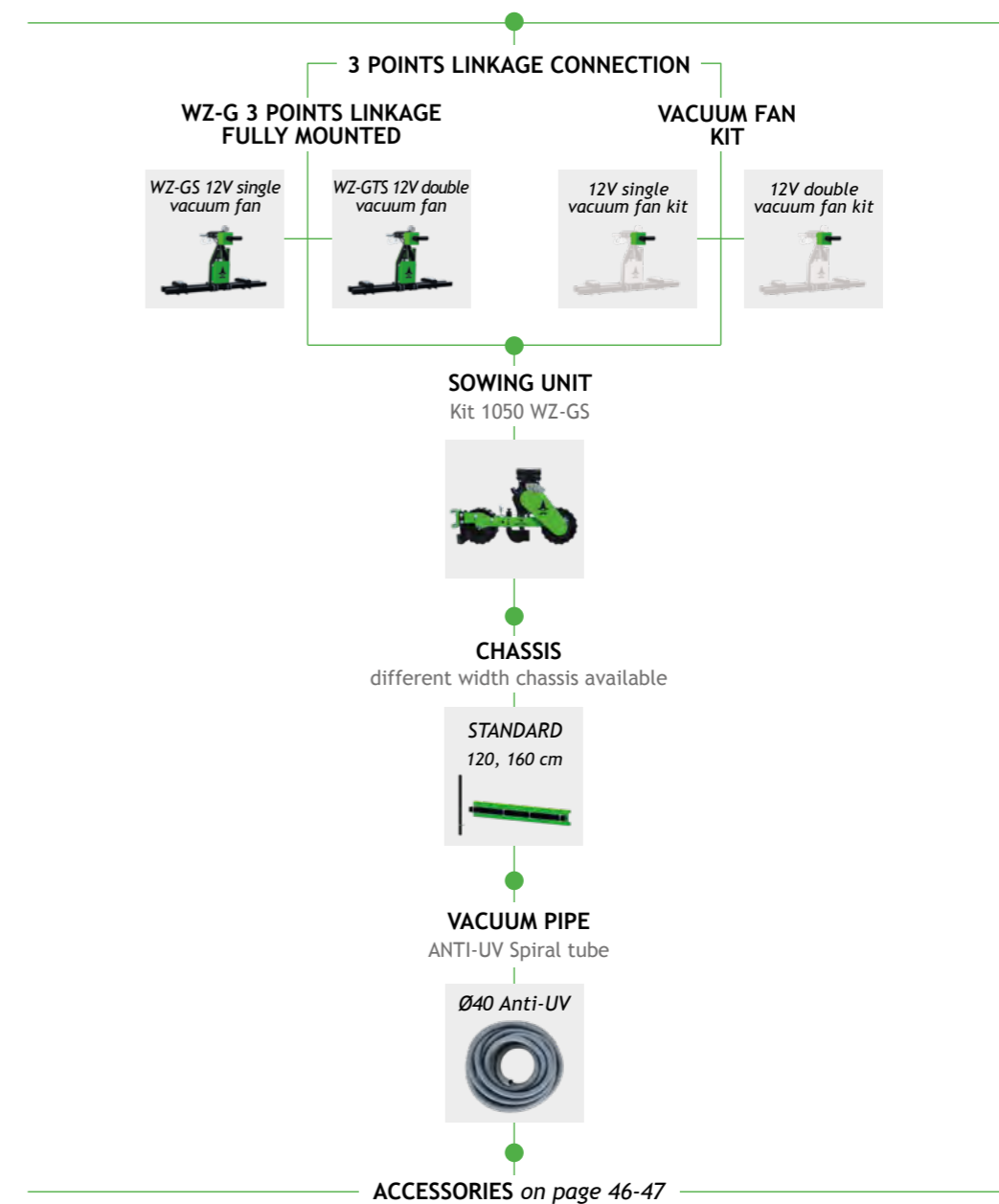

ACCESSORIES



Double wheels

The double wheels increase the contact surface between the machine and the ground, the weight is distributed more and therefore **reduces the sinking**. The machine acquires further **stability** and **maneuverability** in work and maneuvers.



Raised bed sowing
WZ-A10 only

The raised bed sowing kit for WZ-A10 is designed for **small beds** (base max. 85 cm) and is easily applicable by replacing the traditional wheels. The variable distance of the wheels goes from a min of 70 cm to a maximum of 85 cm. This solution allows you to sow over the trunk with the wheels outside it.



Vacuum gauge

It allows the **control of the vacuum** inside the sowing metering units and in turn to regulate it, recommended for those who often vary the sowing crops.



Seed clean out

The seeds clean out kit is divided into two devices, one for the recovery of the minutes and one for the recovery of traditional seeds. They make it possible **not to disperse** the amount of seed left inside the sowing metering unit. For traditional seeds it is a **slide** that is positioned at the base of the seed discharge under the cover of the sowing distributor and once the discharge is opened the seed comes out and can be easily recovered through the slide. Regarding the minute seeds, it is a **seed aspirator** that allows the recovery of the seeds through a container.



Rear pivot wheel
WZ-A20 and WZ-A30 only

This rear wheel, which is excluded during work, improves the transport phase and can also be used for maneuvering on the headland.



Double disc opener

The double disc opener is recommended for sowing on soils with small residues and also avoids clogging compared to the traditional shoe opener. The two discs penetrate the ground and by rotating they make the **residues flow**. Despite its proximity to the ground, each disc is equipped with a shielded bearing which prevents potential clogging of dust. The double disc is **backward compatible** with all our models and is easy to apply.



15 L seed hopper

The 15 L seed hopper allows the operator to perform **greater hours and quantities of worked soil** without having to stop to fill the hoppers. Or for those who, regardless of the amount of soil, use large seeds such as beans, chickpeas and others and therefore a certain volume is necessary even to sow a few quantities.



Row marker

The row marker for the WZ-D series is useful when using this model in the open field to **mark the next row** to pass with the tractor. There are 2 versions, a manual for the smaller models and with a rope for the larger models.

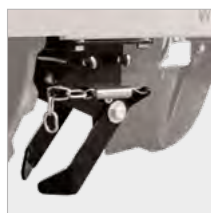

Seed coverer

It improves the **closure of the sowing furrow** allowing a better germination especially with small seeds.



Scraper

Keeps the **rear wheel clean** especially on wetter ground. Keeping the rear wheel clean allows a **better fluidity** of work.





Design, manufacturing and marketing of
the small pneumatic self-propelled precision
planters.

Our products are suitable for
a wide number of users:

- *Small seeding plots*
- *Developing countries*
- *Hobby or semi-professional*
- *Farmers km 0*
- *Greenhouses*
- *Horticulture with small plots*
- *Seed Producers*
- *and many others...*

WIZARD srl

via delle Industrie, 19
33098 Valvasone-Arzene | PN
tel: +39 0434 871461
fax: +39 0434 870351
e-mail: info@wizardagroind.eu
P.Iva: 01781020936
 +39 351 776 2806
 @wizardplanters
 @wizard_planters